

STIHL HS 45

STIHL



2 - 18 Instruction Manual



Contents

1	Guide to Using this Manual.....	2
2	Safety Precautions and Working Techniques.....	2
3	Using the Unit.....	7
4	Fuel.....	8
5	Fueling.....	9
6	Starting / Stopping the Engine.....	9
7	Operating Instructions.....	11
8	Cleaning the Air Filter.....	11
9	Adjusting the Carburetor.....	12
10	Spark Plug.....	12
11	Engine Running Behavior.....	13
12	Lubricating the Gearbox.....	13
13	Storing the Machine.....	13
14	Sharpening Instructions.....	14
15	Inspections and Maintenance by Dealer...	14
16	Maintenance and Care.....	14
17	Minimize Wear and Avoid Damage.....	15
18	Main Parts.....	16
19	Specifications.....	16
20	Maintenance and Repairs.....	17
21	Disposal.....	17
22	EC Declaration of Conformity.....	17
23	UKCA Declaration of Conformity.....	18

Dear Customer,

Thank you for choosing a quality engineered STIHL product.

It has been built using modern production techniques and comprehensive quality assurance. Every effort has been made to ensure your satisfaction and trouble-free use of the product.

Please contact your dealer or our sales company if you have any queries concerning this product.

Your



Dr. Nikolas Stihl

1 Guide to Using this Manual

1.1 Pictograms

The meanings of the pictograms attached to the machine are explained in this manual.

Depending on the model concerned, the following pictograms may be attached to your machine.



Fuel tank; fuel mixture of gasoline and engine oil



Operate manual fuel pump



Filler hole for gear lubricant



Blade lock



Rotating handle

1.2 Symbols in text



WARNING

Warning where there is a risk of an accident or personal injury or serious damage to property.



NOTICE

Caution where there is a risk of damaging the machine or its individual components.

1.3 Engineering improvements

STIHL's philosophy is to continually improve all of its products. For this reason we may modify the design, engineering and appearance of our products periodically.

Therefore, some changes, modifications and improvements may not be covered in this manual.

2 Safety Precautions and Working Techniques



Special safety precautions must be observed when working with this power tool because it has very sharp, high-speed cutting blades.



It is important you read and understand the User Manual before commissioning and keep it in a safe place for future reference. Non-compliance with the User Manual may cause serious or even fatal injury.

Observe all applicable local safety regulations, e.g. by trade organizations, social insurance institutions, labor safety authorities etc.

If you have never used a power tool before: Have your dealer or other experienced user show you how to operate your machine – or attend a special course to learn how to operate it.

Minors are not allowed to work with the power tool – except adolescents above 16 years of age who are instructed under supervision.

Children, animals and bystanders must not be allowed near the machine.

When not using the machine, it must be laid down in such a way that it does not endanger anyone. Ensure that the machine cannot be used without authorization.

The user is responsible for accidents or risks involving third parties or their property.

Do not lend or rent your power tool without the User Manual. Be sure that anyone using it understands the information contained in this manual.

The use of machines that emit noise may be limited to certain hours of the day as specified by national and/or regional or local regulations.

Anyone operating the machine must be well rested, in good physical health and in good mental condition.

If you have any condition that might be aggravated by strenuous work, check with your doctor before operating a machine.

If you have a pacemaker: The ignition system of your machine produces an electromagnetic field of very low intensity. This field may interfere with some pacemakers. STIHL recommends that persons with pacemakers consult their physician and the pacemaker manufacturer to reduce any health risk.

Anyone who has consumed alcohol or drugs or medicines affecting their ability to react must not operate a power tool.

Use the machine only for cutting hedges, shrubs, bushes, scrub and the like. The machine must not be used for any other purposes – **risk of accidents!**

Other uses are not permitted and may lead to accidents or damage to the machine. Never attempt to modify your power tool in any way since this may result in accidents or damage to the machine.

Only use cutting blades and accessories that are explicitly approved for this power tool by STIHL or are technically identical. If you have any questions in this respect, consult your dealer. Use only high quality parts and accessories. In order to avoid the risk of accidents and damage to the machine.

STIHL recommends the use of original STIHL tools and accessories. They are specifically designed to match the product and meet your performance requirements.

Never attempt to modify your power tool in any way since this may increase the risk of personal injury. STIHL excludes all liability for personal injury and damage to property caused while using unauthorized attachments.

Do not use a high-pressure washer to clean the power tool. The solid jet of water may damage parts of the unit.

2.1 Clothing and equipment

Wear proper protective clothing and equipment.



Clothing must be sturdy but allow complete freedom of movement. Wear close-fitting clothes such as a boiler suit, not a loose jacket.

Do not wear clothing which could become trapped in wood, brush or moving parts of the machine. Do not wear a scarf, necktie or jewelry. Tie up and confine long hair above your shoulders.

Wear sturdy shoes with non-slip soles.



WARNING



To reduce the risk of eye injuries, wear close-fitting safety glasses in accordance with European Standard EN 166. Make sure the safety glasses are a snug fit.

Wear "personal" sound protection, e.g. ear defenders.



Wear sturdy protective gloves made of a resistant material (e. g. leather).

STIHL can supply a comprehensive range of personal protective equipment.

2.2 Transporting the machine

Always stop the engine.

Attach the blade scabbard even when carrying the machine over short distances.

Carry the power tool by the handle – cutting blades behind you. Do not touch hot parts of the machine, especially the muffler and gear housing – **risk of burns!**

By vehicle: When transporting in a vehicle, properly secure your machine to prevent turnover, damage and fuel spillage.

2.3 Refueling



Gasoline is an extremely flammable fuel. Keep clear of naked flames. Do not spill any fuel – do not smoke.

Always **shut off the engine** before refueling.

Do not fuel a hot engine – **fuel may spill and cause a fire.**

Open the fuel cap carefully to allow any pressure build-up in the tank to release slowly and avoid fuel spillage.

Only refuel the machine in a well ventilated place. If fuel has been spilled, immediately clean the machine – do not allow your clothes to be splashed with fuel. If that happens, change your clothes at once.

The power tools may be fitted as standard with different fuel caps.



After fueling, tighten down the screw-type fuel cap as securely as possible.



Place the clip lock fuel cap (bayonet-type) in position, turn it until it will go no further and fold the clip lock down.

This helps reduce the risk of unit vibrations causing an incorrectly tightened fuel cap to loosen or come off and spill quantities of fuel.

Check for leaks. Do not start the engine if there is a fuel leak – **serious or fatal burns could result!**

2.4 Before starting

Check that your power tool is properly assembled and in good condition – refer to appropriate chapters in the User Manual:

- Check the fuel system for leaks, especially the visible parts, e. g., fuel cap, hose connections, manual fuel pump (only in machines with a manual fuel pump). In case of leakage and damage, do not start the engine – **risk of fire!** Have the machine serviced by a dealer before using it
- Insert the blade lock (if fitted)
- Slide control / stop switch must move easily to **STOP** or **0**
- Smooth action of throttle trigger lockout and throttle trigger – the throttle trigger must return automatically to the idle position

- Check that the spark plug boot is secure – a loose boot may cause sparking that could ignite combustible fumes **and cause a fire!**
- Cutting blades must be properly tightened and in safe operating condition (clean, sharp, not bent or warped), correctly mounted and thoroughly sprayed with STIHL resin solvent (lubricant)
- Check cutter guard (if fitted) for damage
- Never attempt to modify the controls or safety devices
- Keep the handles dry and clean – free from oil and dirt – this is important for safe control of the machine

To reduce the risk of personal injury, do not operate your power tool if it is damaged or not properly assembled!

2.5 Starting the engine

Start the engine at least 3 meters from the fueling spot, outdoors only.

Place the power tool on firm ground in an open area. Make sure you have good balance and secure footing. Hold the power tool securely. The cutting blades must be clear of the ground and all other obstructions because they may begin to run when the engine starts.

Your power tool is designed to be operated by one person only. Do not allow other persons in the work area – even when starting.

Avoid contact with the cutting blades – **risk of injury!**

Do not drop-start the engine – start it as described in the User Manual.

Note that the cutting blades continue to run for a short period after you let go of the throttle trigger – **flywheel effect!**

Check engine idling: The cutting blades must remain at a standstill when the engine idles – throttle trigger released.

2.6 Holding and guiding the machine

Always hold the unit firmly with both hands on the handles. Wrap your fingers and thumbs around the handles.

2.6.1 Right-handed users

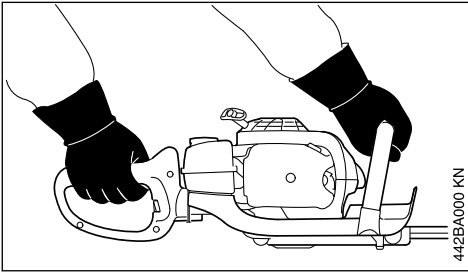

Right hand on the control handle and left hand on the handlebar.

2.6.2 Left-handed users

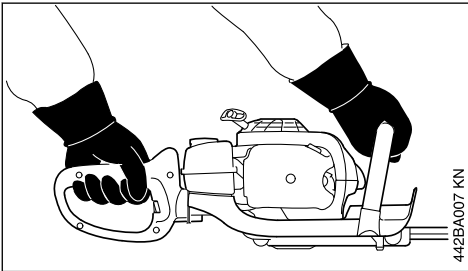

Left hand on the control handle and right hand on the handlebar.

Make sure you always have a good footing and hold the machine so that the cutting blades are always facing away from your body.

2.7 While working

In the event of impending danger or in an emergency, switch off the engine immediately – move the slide control / stop switch to **0** or **STOP**.

Ensure that there are no bystanders within the working area.

Watch the cutting blades at all times – do not cut areas of the hedge that you cannot see.

Be extremely careful when cutting tall hedges, check the other side of the hedge before starting work.

Check for correct idling, so that the cutting blades stop moving when the throttle trigger is released.

If the cutting blades still move, have the machine repaired by your specialist dealer. Check and correct the idle speed setting at regular intervals.

Note that the cutting blades continue to run for a short period after you let go of the throttle trigger – **flywheel effect!**

The gearhead becomes hot during operation. **To reduce the risk of burn injury, do not touch the gear housing!**

Take special care in slippery and wet conditions, in snow, on slopes or uneven ground, etc. – **risk of slipping!**

Clear away fallen branches, scrub and cuttings.

Watch out for obstacles: tree stumps, roots – **risk of tripping or stumbling!**

Make sure you always have good balance and secure footing.

2.7.1 When working at heights:

- Always use a lift bucket
- Never use the machine while standing on a ladder or in a tree
- Never work on an insecure support
- Never use the machine with just one hand

Be particularly alert and cautious when wearing hearing protection because your ability to hear warnings (shouts, alarms, etc.) is restricted.

Take breaks when you start getting tired or feeling fatigue – **risk of accidents!**

Work calmly and carefully – in daylight conditions and only when visibility is good. Proceed with caution, do not put others in danger.



As soon as the engine is running, the power machine generates toxic exhaust gas. These gases may be odorless and invisible and may contain unburned hydrocarbons and benzene. Never run the engine indoors or in poorly ventilated locations, even if your model is equipped with a catalytic converter.

To reduce the risk of **serious or fatal injury from breathing toxic fumes**, ensure proper ventilation when working in trenches, hollows or other confined locations.

Stop work immediately if you start suffering from nausea, headaches, impaired vision (e.g. your field of vision gets smaller), impaired hearing, dizziness, or impaired concentration – these symptoms may possibly be the result of too-high exhaust gas concentration – **Risk of accidents!**

Operate your power tool so that it produces a minimum of noise and emissions – do not run the engine unnecessarily, accelerate the engine only when working.

To reduce the risk of fire, **do not smoke** while operating or standing near your power tool. Combustible fuel vapor may escape from the fuel system.

If your power tool is subjected to unusually high loads for which it was not designed (e.g. heavy impact or a fall), always check that it is in good condition before continuing work – see also "Before Starting". Check in particular that the fuel system has no leaks and the safety equipment is fully operative. Never use a power tool that is no longer safe to operate. In case of doubt, contact a dealer.

Do not operate your power tool in the starting throttle position – engine speed cannot be controlled in this position.

Inspect the hedge and work area to avoid damaging the cutting blades:

- Remove stones, rocks, pieces of metal and other solid objects
- Ensure that no sand or small stones get between the cutting blades, e.g. when working close to the ground.
- When cutting hedges next to or against wire fences, do not touch wire with the cutting blades

Do not touch electric power lines – never cut through electric power lines – **risk of electrocution!**



Do not touch the cutting blades while the engine is running. If the cutting blades become jammed by an object, switch off the engine immediately before attempting to remove the object – **risk of injury!**

Opening the throttle when the cutting blades are jammed increases the load and reduces the working speed of the engine. The clutch then slips continuously and this causes overheating and damage to important components (e.g. clutch, plastic housing components) – as a result, there is a **risk of injury!** from the idling cutting blades

If the hedge is very dusty or dirty, spray the cutting blades with STIHL resin solvent from time to time during cutting. This will significantly reduce blade friction, the aggressive effects of sap and the build-up of dirt particles.

The dust which is generated during operation may be harmful to health. Wear a dust mask in case of dust formation.

Before you leave the machine: Shut the engine off.

Check the cutting blades at regular short intervals during operation or immediately if there is a noticeable change in cutting behavior:

- Shut off the engine
- Wait for cutting blades to come to a standstill
- Check the condition and firm seat, watch out for fine cracks
- Ensure that the cutting blades are sharp

Always clean plant residue, chips, leaves and excess lubricant off the engine and muffler – **risk of fire!**

2.8 After finishing work

Always clean dust and dirt off the machine – do not use any grease solvents for this purpose.

Spray the cutting blades with STIHL resin solvent. Run the motor briefly so that the solvent is evenly distributed.

2.9 Vibrations

Prolonged use of the power tool may result in vibration-induced circulation problems in the hands (whitefinger disease).

No general recommendation can be given for the length of usage because it depends on several factors.

The period of usage is prolonged by:

- Hand protection (wearing warm gloves)
- Work breaks

The period of usage is shortened by:

- Any personal tendency to suffer from poor circulation (symptoms: frequently cold fingers, tingling sensations).
- Low outside temperatures.
- The force with which the handles are held (a tight grip restricts circulation).

Continual and regular users should monitor closely the condition of their hands and fingers. If any of the above symptoms appear (e.g. tingling sensation in fingers), seek medical advice.

2.10 Maintenance and Repairs

Service the machine regularly. Do not attempt any maintenance or repair work not described in the instruction manual. Have all other work performed by a servicing dealer.

STIHL recommends that you have servicing and repair work carried out exclusively by an authorized STIHL servicing dealer. STIHL dealers are

regularly given the opportunity to attend training courses and are supplied with the necessary technical information.

Only use high-quality replacement parts in order to avoid the risk of accidents and damage to the machine. If you have any questions in this respect, consult a servicing dealer.

STIHL recommends the use of genuine STIHL replacement parts. They are specifically designed to match your model and meet your performance requirements.

To reduce the risk of injury, **always shut off the engine** before carrying out any maintenance or repairs or cleaning the machine. – Exception: Carburetor and idle speed adjustments.

Do not turn the engine over on the starter with the spark plug boot or spark plug removed unless the slide control / stop switch is on **STOP** or **0** since there is otherwise a **risk of fire** from uncontained sparking.

To reduce the **risk of fire**, do not service or store your machine near open flames.

Check the fuel filler cap for leaks at regular intervals.

Use only a spark plug of the type approved by STIHL and make sure it is in good condition – see "Specifications".

Inspect the ignition lead (insulation in good condition, secure connection).

Check the condition of the muffler.

To reduce the **risk of fire and damage to hearing**, do not operate your machine if the muffler is damaged or missing.

Do not touch a hot muffler since **burn injury** will result.

Vibration behavior is influenced by the condition of the AV elements – check the AV elements at regular intervals.

3 Using the Unit

3.1 Cutting Season

Observe country-specific or municipal rules and regulations for cutting hedges.

Do not use your power tool during other people's normal rest periods.

3.2 Cutting Sequence

Use lopping shears or a chain saw to cut out thick branches first.

Cut both sides of the hedge first, then the top.

3.3 Disposal

Do not throw cuttings in the garbage can – they can be composted!

3.4 Working Technique

3.4.1 Vertical Cut

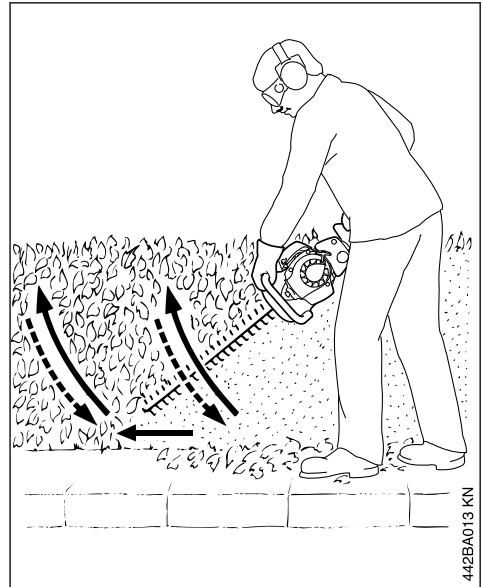

Swing the cutting blade from the bottom upwards in an arc – lower the nose of the blade, move along the hedge and then swing the blade up again in an arc.

Any working position above head height is tiring. To minimize the risk of accidents, work in such positions for short periods only.

3.4.2 Horizontal Cut

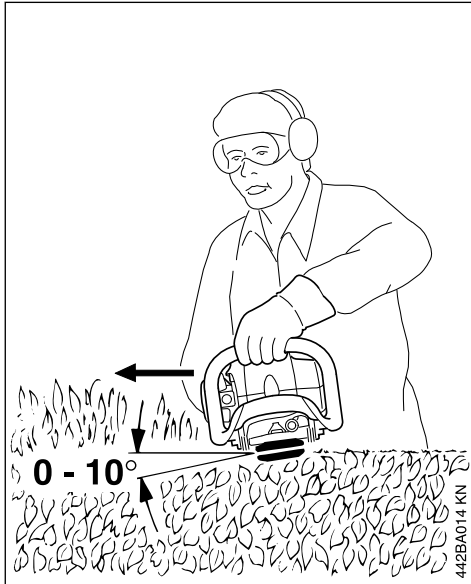

Hold the cutter bar at an angle of 0° to 10° as you swing the hedge trimmer horizontally.

Swing the cutting blade in an arc towards the outside of the hedge so that the cuttings are swept to the ground.

4 Fuel

Your engine requires a mixture of gasoline and engine oil.



WARNING

For health reasons, avoid direct skin contact with gasoline and avoid inhaling gasoline vapor.

4.1 STIHL MotoMix

STIHL recommends the use of STIHL MotoMix. This ready-to-use fuel mix contains no benzol or lead, has a high octane rating and ensures that you always use the right mix ratio.

STIHL MotoMix uses STIHL HP Ultra two-stroke engine oil for an extra long engine life.

MotoMix is not available in all markets.

4.2 Mixing Fuel

NOTICE

Unsuitable fuels or lubricants or mix ratios other than those specified may result in serious damage to the engine. Poor quality gasoline or engine oil may damage the engine, sealing rings, hoses and the fuel tank.

4.2.1 Gasoline

Use only high-quality **brand-name** gasoline with a minimum octane rating of 90 – leaded or unleaded.

Gasoline with an ethanol content of more than 10% can cause running problems in engines with a manually adjustable carburetor and should not be used in such engines.

Engines equipped with M-Tronic deliver full power when run on gasoline with an ethanol content of up to 25% (E25).

4.2.2 Engine Oil

If you mix the fuel yourself, use only STIHL two-stroke engine oil or another high-performance engine oil in accordance with JASO FB, JASO FC, JASO FD, ISO-L-EGB, ISO-L-EGC or ISO-L-EGD.

STIHL specifies STIHL HP Ultra two-stroke engine oil or an equivalent high-performance engine oil in order to maintain emission limits over the machine's service life.

4.2.3 Mix Ratio

STIHL 50:1 two-stroke engine oil: 50 parts gasoline to 1 part oil

4.2.4 Examples

Gasoline Liters	STIHL engine oil 50:1 Liters	(ml)
1	0.02	(20)
5	0.10	(100)
10	0.20	(200)
15	0.30	(300)
20	0.40	(400)
25	0.50	(500)

- Use a canister approved for storing fuel. Pour oil into canister first, then add gasoline and mix thoroughly.

4.3 Storing Fuel

Store fuel only in approved safety-type fuel canisters in a dry, cool and safe location protected from light and the sun.

Fuel mix ages – only mix sufficient fuel for a few weeks work. Do not store fuel mix for longer than 30 days. Exposure to light, the sun, low or high temperatures can quickly make the fuel mix unusable.

STIHL MotoMix may be stored for up to 2 years without any problems.

- ▶ Thoroughly shake the mixture in the canister before fueling your machine.

! WARNING

Pressure may build up in the canister – open it carefully.

- ▶ Clean the fuel tank and canister from time to time.

Dispose of remaining fuel and cleaning fluid properly in accordance with local regulations and environmental requirements.

5 Fueling



5.1 Preparations

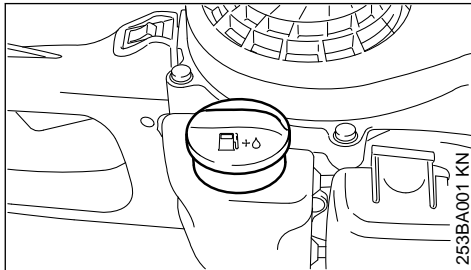

- ▶ Before fueling, clean the filler cap and the area around it to ensure that no dirt falls into the tank.
- ▶ Position the machine so that the filler cap is facing up.
- ▶ Open the filler cap.

5.2 Fill up with fuel.

Take care not to spill fuel while fueling and do not overfill the tank.

STIHL recommends you use the STIHL filler nozzle for fuel (special accessory).

! WARNING

After fueling, tighten down the filler cap as securely as possible by hand.

6 Starting / Stopping the Engine

- ▶ Observe safety precautions – see chapter on "Safety Precautions and Working Techniques".

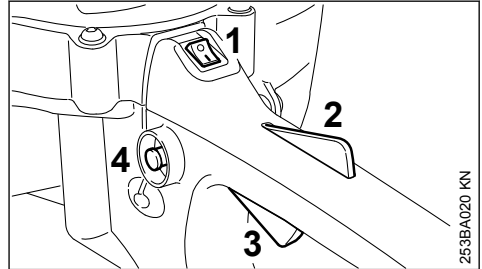

- ▶ Move the stop switch (1) to I.
- ▶ Press down the lockout lever (2) and squeeze the throttle trigger (3) – hold both levers in that position.
- ▶ Press in the starting throttle lock (4).
- ▶ Let go of the lockout lever, throttle trigger and starting throttle lock. This is the starting throttle position.

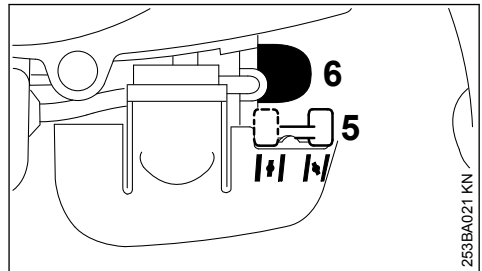

- ▶ Set the choke lever (5) to  if the engine is cold for warm start – also use this position if the engine has been running but is still cold.
- ▶ Press the manual fuel pump bulb (6) at least five times – even if the bulb is filled with fuel.

6.1 Cranking

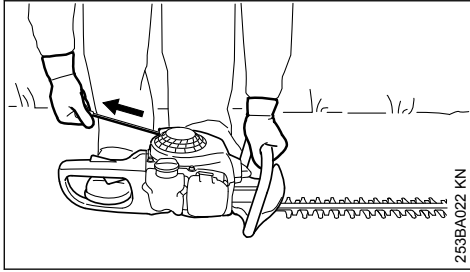

253BA023 KN

- ▶ Place the unit on the ground.
- ▶ Remove the blade scabbard. Check that the cutting blades are not touching the ground or any other obstacles.
- ▶ Make sure you have a safe and secure footing.
- ▶ Hold the unit firmly with your left hand on the front handle and press down.
- ▶ Pull the starter grip slowly with your right hand until you feel it engage and then give it a brisk strong pull.

NOTICE

Do not pull out the starter rope all the way – it **might otherwise break**.

- ▶ Do not let the starter grip snap back. Guide it slowly back into the housing so that the starter rope can rewind properly.

6.1.1 If the engine is cold (choke set to \curvearrowright)

- ▶ Pull the starter rope five times.
- ▶ Set choke lever to $| \uparrow |$ and
- ▶ continue cranking until the engine runs.

If conditions are unfavorable and the engine does not start after 10 pulls with the choke lever set to $| \uparrow |$:

- ▶ Set choke to \curvearrowright and pull starter rope five times. Set choke to $| \uparrow |$ and continue cranking.

6.1.2 If the engine is warm (choke set to $| \uparrow |$)

- ▶ Continue cranking until the engine runs.

6.2 As Soon as Engine Runs

- ▶ Blip the throttle trigger – the engine settles down to idle speed.

6.2.1 If the engine stops during warm-up or acceleration

- ▶ Repeat the starting procedure as described under "If the engine is cold".

! WARNING

Make sure the carburetor is correctly adjusted. The cutting blades must not move when the engine is idling.

Your machine is now ready for operation.

6.3 Stopping the Engine

- ▶ Move the stop switch to O.

6.4 Other Hints on Starting

6.4.1 If the engine does not start

- ▶ Make sure all settings are correct (choke shutter, throttle trigger in starting throttle position, stop switch to I).
- ▶ Repeat the starting procedure.

If the engine still does not start

- ▶ Remove the spark plug – see "Spark Plug".
- ▶ Dry the spark plug.
- ▶ Open the throttle wide.
- ▶ Crank the engine several times with the starter to clear the combustion chamber.
- ▶ Install the spark plug – see "Spark Plug".
- ▶ Move the stop switch to I.
- ▶ Set choke lever to $| \uparrow |$ – even if the engine is cold.
- ▶ Now start the engine.

6.4.2 If fuel tank has been run completely dry and then refueled

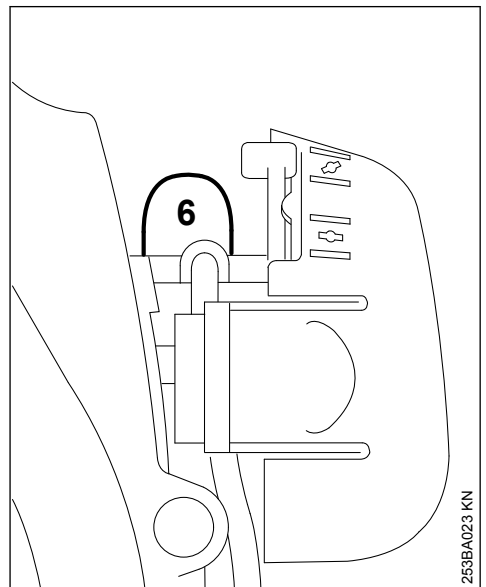

253BA023 KN

- ▶ Press the manual fuel pump bulb (6) at least five times – even if the bulb is filled with fuel.
- ▶ Now start the engine.

7 Operating Instructions

7.1 During break-in period

A factory-new machine should not be run at high revs (full throttle off load) for the first three tank fillings. This avoids unnecessary high loads during the break-in period. As all moving parts have to bed in during the break-in period, the frictional resistances in the engine are greater during this period. The engine develops its maximum power after about 5 to 15 tank fillings.

7.2 During Operation

After a long period of full throttle operation, allow the engine to run for a short while at idle speed so that engine heat can be dissipated by the flow of cooling air. This protects engine-mounted components (ignition, carburetor) from thermal overload.

7.3 After Finishing Work

Storing for a short period: Wait for the engine to cool down. Empty the fuel tank and keep the machine in a dry place, well away from sources of ignition, until you need it again. For longer out-of-service periods – see "Storing the Machine".

8 Cleaning the Air Filter

8.1 If there is a noticeable loss of engine power

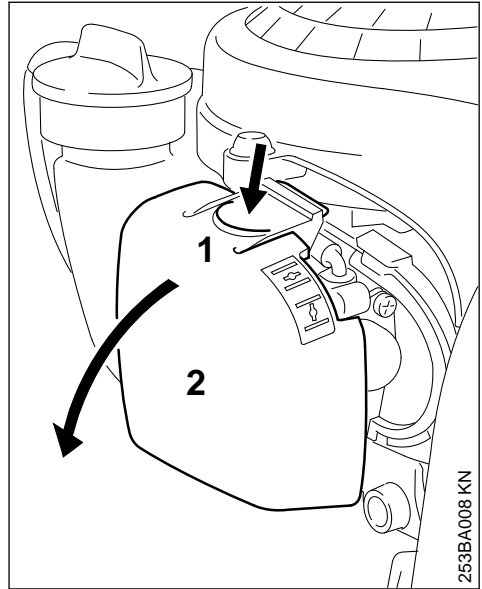

- ▶ Move the choke lever to $\overline{\text{I}}$.
- ▶ Press in the tab (1) and swing the filter cover (2) down.
- ▶ Clean away loose dirt from around the filter.

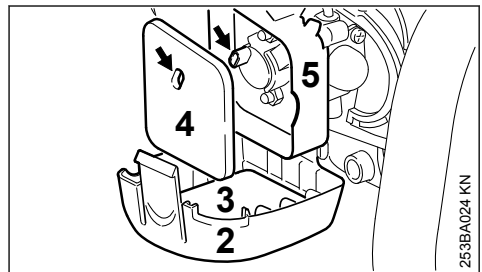

- ▶ Remove the foam element (3) and felt element (4).
- ▶ Wash the foam element in a clean, non-flammable solution (e.g. soapy water) and then dry.
- ▶ Fit a new felt element. As a temporary measure you can knock it out on the palm of your hand or blow it out with compressed air. Do not wash.
- ▶ Replace any damaged parts.

- ▶ Fit the foam element (3) in the filter cover (2) and the felt element (4) in the filter housing (5).
- ▶ Close the filter cover so that it snaps into position.

9 Adjusting the Carburetor

The carburetor has been set at the factory to provide an optimum fuel-air mixture under most operating conditions.

9.1 Adjusting Idle Speed

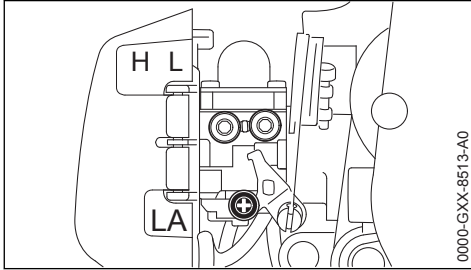

- ▶ Start and warm up the engine.

9.1.1 Engine stops while idling

- ▶ Turn the idle speed screw (LA) slowly clockwise until the engine runs smoothly – the cutting blades must not run.

9.1.2 Cutting blades run when engine is idling

- ▶ Turn the idle speed screw (LA) counterclockwise until the cutting blades stop moving – then turn it another 1/2 to 1 turn in the same direction.



WARNING

If the cutting blades continue to run while the engine is idling, have your power tool checked and repaired by your servicing dealer.

10 Spark Plug

- ▶ If the engine is down on power, difficult to start or runs poorly at idle speed, first check the spark plug.
- ▶ Fit a new spark plug after about 100 operating hours – or sooner if the electrodes are badly eroded. Install only suppressed spark plugs of the type approved by STIHL – see "Specifications".

10.1 Removing the Spark Plug

- ▶ Move the stop switch to **O**.

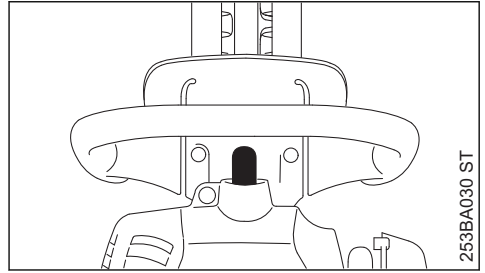

- ▶ Pull off the spark plug boot.
- ▶ Unscrew the spark plug.

10.2 Checking the Spark Plug

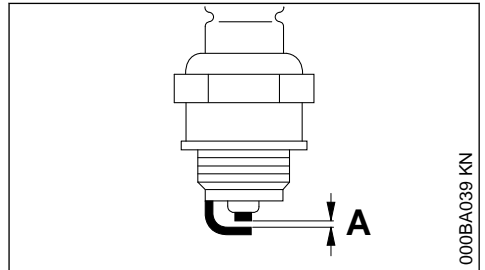

- ▶ Clean dirty spark plug.
- ▶ Check electrode gap (A) and readjust if necessary – see "Specifications".
- ▶ Rectify the problems which have caused fouling of the spark plug.

Possible causes are:

- Too much oil in fuel mix.
- Dirty air filter.
- Unfavorable running conditions.

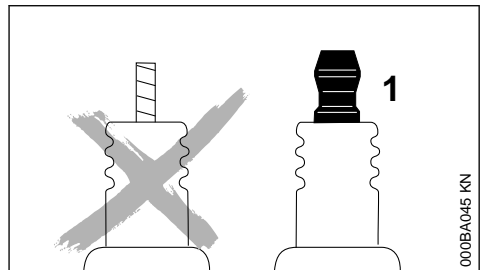

! WARNING

Arcing may occur if the adapter nut (1) is loose or missing. Working in an easily combustible or explosive atmosphere may cause a fire or an explosion. This can result in serious injuries or damage to property.

- ▶ Use resistor type spark plugs with a properly tightened adapter nut.

10.3 Installing the spark plug

- ▶ Fit the spark plug by hand and screw it in
- ▶ Tighten spark plug with combination wrench
- ▶ Press the spark plug boot firmly onto the spark plug

11 Engine Running Behavior

If engine running behavior is unsatisfactory even though the air filter is clean and the carburetor is properly adjusted, the cause may be the muffler.

Have the muffler checked for contamination (carbonization) by your servicing dealer.

STIHL recommends that you have servicing and repair work carried out exclusively by an authorized STIHL servicing dealer.

12 Lubricating the Gearbox

Use STIHL gear lubricant for hedge trimmers (special accessory) to lubricate the blade drive gear.

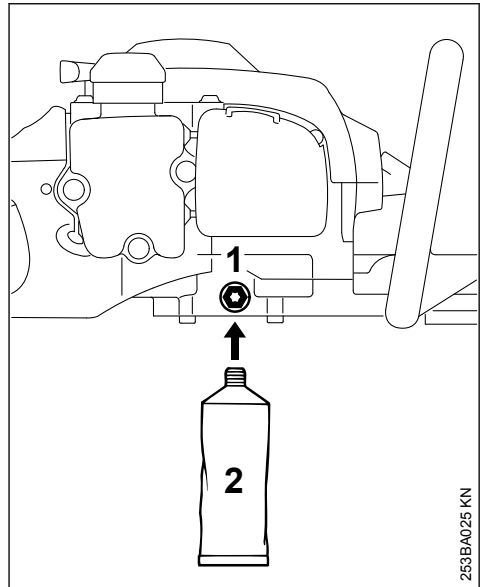

After about 50 hours of operation:

- ▶ Remove the screw plug (1) from the gearbox.
- ▶ Screw the tube of grease (2) into the filler hole.
- ▶ Squeeze up to 5 g grease into the gearbox.

NOTICE

Do not completely fill the gearbox with grease.

- ▶ Remove the tube of grease (2).
- ▶ Refit the filler plug and tighten it down firmly.

13 Storing the Machine

For periods of 3 months or longer

- ▶ Drain and clean the fuel tank in a well ventilated area.
- ▶ Dispose of fuel properly in accordance with local environmental requirements.
- ▶ Run the engine until the carburetor is dry – this helps prevent the carburetor diaphragms sticking together.
- ▶ Clean the cutting blades, check condition and spray with STIHL resin solvent.
- ▶ Fit the blade scabbard.
- ▶ Thoroughly clean the machine – pay special attention to the cylinder fins and air filter.
- ▶ Store the machine in a dry and safe location (use the ring integrated in the rear handle) out of the reach of children and other unauthorized persons.

14 Sharpening Instructions

When cutting performance and behavior begin to deteriorate, i.e. blades frequently snag on branches: Resharpen the cutting blades.

It is best to have the cutting blades resharpened by a dealer on a workshop sharpener. STIHL recommends a STIHL servicing dealer.

It is also possible to use a flat crosscut sharpening file. Hold the sharpening file at the prescribed angle (see "Specifications").

- ▶ Only sharpen the cutting edge – do not file blunt projecting parts of the cutting blade or the cutting blade guard (see "Main Parts and Controls")
- ▶ Always file towards the cutting edge.
- ▶ The file only sharpens on the forward stroke – lift it off the blade on the backstroke.
- ▶ Use a whetstone to remove burr from cutting edge.
- ▶ Remove as little material as possible.

- ▶ After sharpening, clean away filing or grinding dust and then spray the cutting blades with STIHL resin solvent.

NOTICE

Do not operate your machine with dull or damaged cutting blades. This may cause overload and will give unsatisfactory cutting results.

15 Inspections and Maintenance by Dealer

15.1 Maintenance Work

STIHL recommends that you have servicing and repair work carried out exclusively by an authorized STIHL servicing dealer.

15.2 Fuel Pickup Body in Tank

- ▶ Have the pickup body in the fuel tank replaced every year.

16 Maintenance and Care

The following intervals apply to normal operating conditions only. If your daily working time is longer or operating conditions are difficult (very dusty work area, etc.), shorten the specified intervals accordingly.		before starting work	after finishing work or daily	after each refueling stop	weekly	monthly	every 12 months	if problem	if damaged	as required
Complete machine	Visual inspection (condition, leaks)	X		X						
	Clean		X							
Control handle	Check operation	X		X						
Air filter	Clean							X		X
	Replace								X	
Manual fuel pump (if fitted)	Check	X								
	Have repaired by servicing dealer ¹⁾								X	
Pickup body (filter) in fuel tank	Have checked by servicing dealer ¹⁾							X		
	Have replaced by servicing dealer ¹⁾						X		X	X
Fuel tank	Clean							X		X
Carburetor	Check idle adjustment	X		X						
	Readjust idle									X
Spark plug	Readjust electrode gap							X		
	Replace after every 100 operating hours									

The following intervals apply to normal operating conditions only. If your daily working time is longer or operating conditions are difficult (very dusty work area, etc.), shorten the specified intervals accordingly.		before starting work	after finishing work or daily	after each refueling stop	weekly	monthly	every 12 months	if problem	if damaged	as required
Cooling air inlet	Visual inspection		X							
	Clean									X
All accessible screws and nuts (not adjusting screws)	Retighten									X
Antivibration elements	Visual inspection	X								
	Have replaced by servicing dealer ¹⁾							X	X	
Cutting blades	Clean		X							
	Sharpen									X
	Visual inspection	X								
	Have replaced by servicing dealer ¹⁾								X	
Gearbox lubrication	Check and replenish after every 50 hours of operation									
Safety labels	Replace								X	
1)STIHL recommends an authorized STIHL servicing dealer.										

17 Minimize Wear and Avoid Damage

Observing the instructions in this manual helps reduce the risk of unnecessary wear and damage to the power tool.

The power tool must be operated, maintained and stored with the due care and attention described in this owner's manual.

The user is responsible for all damage caused by non-observance of the safety precautions, operating and maintenance instructions in this manual. This includes in particular:

- Alterations or modifications to the product not approved by STIHL.
- Using tools or accessories which are neither approved or suitable for the product or are of a poor quality.
- Using the product for purposes for which it was not designed.
- Using the product for sports or competitive events.
- Consequential damage caused by continuing to use the product with defective components.

17.1 Maintenance Work

All the operations described in the "Maintenance Chart" must be performed on a regular basis. If these maintenance operations cannot be performed by the owner, they should be performed by a servicing dealer.

STIHL recommends that you have servicing and repair work carried out exclusively by an authorized STIHL servicing dealer. STIHL dealers are regularly given the opportunity to attend training courses and are supplied with the necessary technical information.

If these maintenance operations are not carried out as specified, the user assumes responsibility for any damage that may occur. Among other parts, this includes:

- Damage to the engine due to neglect or deficient maintenance (e.g. air and fuel filters), incorrect carburetor adjustment or inadequate cleaning of cooling air inlets (intake ports, cylinder fins).
- Corrosion and other consequential damage resulting from improper storage.

- Damage to the machine resulting from the use of poor quality replacement parts.

17.2 Parts Subject to Wear and Tear

Some parts of the power tool are subject to normal wear and tear even during regular operation in accordance with instructions and, depending on the type and duration of use, have to be replaced in good time. Among other parts, this includes:

- Cutting blades
- Clutch
- Filters (air, fuel)
- Rewind starter
- Spark plug
- Components of antivibration system

18 Main Parts

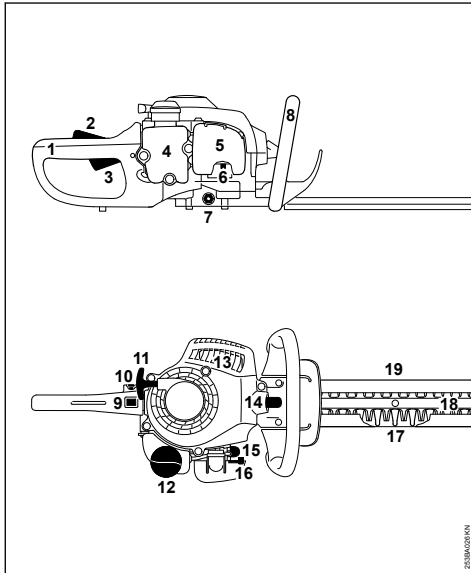

- 1 Rear Handle
- 2 Throttle Trigger Lockout
- 3 Throttle Trigger
- 4 Fuel Tank
- 5 Air Filter Cover
- 6 Idle Speed Screw (LA)
- 7 Screw Plug
- 8 Front Handle
- 9 Stop Switch
- 10 Lock Button

- 11 Starter Grip
- 12 Fuel Tank Cap
- 13 Muffler
- 14 Spark Plug Boot
- 15 Manual Fuel Pump
- 16 Choke Lever
- 17 Cutter Guard
- 18 Cutting Blades
- 19 Blade Scabbard

19 Specifications

19.1 Engine

STIHL single cylinder two-stroke engine

Displacement:	27.2 cc
Bore:	34 mm
Stroke:	30 mm
Engine power to ISO 7293:	0.75 kW (1 bhp) at 8,500 rpm
Idle speed:	2,800 rpm
Cut-off speed:	10,300 rpm

19.2 Ignition System

Electronic magneto ignition

Spark plug (resistor type):	NGK CMR6H
Electrode gap:	0.5 mm

19.3 Fuel System

All position diaphragm carburetor with integral fuel pump

Fuel tank capacity:	225 cc (0.225 l)
---------------------	------------------

19.4 Weight

complete with cutting attachment, dry

450 mm blade:	4.7 kg
600 mm blade:	5.0 kg

19.5 Cutting Blades

Sharpening angle to horizontal:	35°
---------------------------------	-----

19.6 Noise and Vibration Data

For further details on compliance with Vibration Directive 2002/44/EC see www.stihl.com/vib.

19.6.1 Sound pressure level L_p to ISO 22868

450 mm blade:	97 dB(A)
600 mm blade:	97 dB(A)

19.6.2 Sound power level L_w to ISO 22868

450 mm blade:	107 dB(A)
600 mm blade:	107 dB(A)

19.6.3 Vibration measurement $a_{HV,eq}$ to ISO 22867

	Handle, left	Handle, right
450 mm blade:	10.0 m/s ²	9.0 m/s ²
600 mm blade:	10.0 m/s ²	9.0 m/s ²

The K-factor in accordance with Directive 2006/42/EC is 2.0 dB(A) for the sound pressure level and sound power level; the K-factor in accordance with Directive 2006/42/EC is 2.0 m/s² for the vibration level.

19.7 REACH

REACH is an EC regulation and stands for the Registration, Evaluation, Authorisation and Restriction of Chemical substances.

For information on compliance with the REACH regulation (EC) No. 1907/2006 see www.stihl.com/reach.

19.8 Exhaust Emissions

The CO₂ value measured in the EU type approval procedure is specified at www.stihl.com/co2.

The measured CO₂ value was determined on a representative engine in accordance with a standardized test procedure under laboratory conditions and does not represent either an explicit or implied guarantee of the performance of a specific engine.

The applicable exhaust emission requirements are fulfilled by the intended usage and maintenance described in this instruction manual. The type approval expires if the engine is modified in any way.

20 Maintenance and Repairs

Users of this machine may only carry out the maintenance and service work described in this user manual. All other repairs must be carried out by a servicing dealer.

STIHL recommends that you have servicing and repair work carried out exclusively by an authorized STIHL servicing dealer. STIHL dealers are regularly given the opportunity to attend training courses and are supplied with the necessary technical information.

When repairing the machine, only use replacement parts which have been approved by STIHL for this power tool or are technically identical. Only use high-quality replacement parts in order to avoid the risk of accidents and damage to the machine.

STIHL recommends the use of original STIHL replacement parts.

Original STIHL parts can be identified by the STIHL part number, the **STIHL** logo and the STIHL parts symbol  (the symbol may appear alone on small parts).

21 Disposal

Observe all country-specific waste disposal rules and regulations.

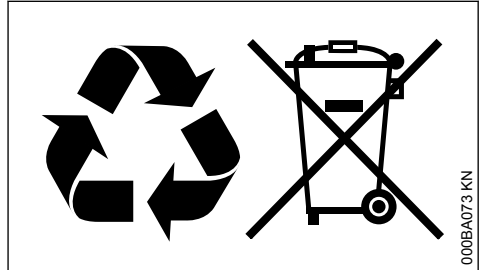

STIHL products must not be thrown in the garbage can. Take the product, accessories and packaging to an approved disposal site for environment-friendly recycling.

Contact your STIHL servicing dealer for the latest information on waste disposal.

22 EC Declaration of Conformity

ANDREAS STIHL AG & Co. KG
Badstr. 115
D-71336 Waiblingen

Germany

declare under our sole responsibility that

Designation:	Hedge trimmer
Make:	STIHL
Series:	HS 45
Serial identification number:	4228
Displacement:	27.2cm ³

conforms to the relevant provisions of Directives 2011/65/EU, 2006/42/EC, 2014/30/EU and 2000/14/EC and has been developed and manufactured in compliance with the following standards in the versions valid on the date of production:

EN ISO 10517, EN 55012, EN 61000-6-1

The measured and the guaranteed sound power level have been determined in accordance with

Directive 2000/14/EC, Annex V, and standard ISO 11094.

Measured sound power level

102 dB(A)

Guaranteed sound power level

104 dB(A)

Technical documents deposited at:

ANDREAS STIHL AG & Co. KG
Produktzulassung

The year of manufacture and serial number are applied to the product.

Done at Waiblingen, 15.07.2021

ANDREAS STIHL AG & Co. KG

pp



Dr. Jürgen Hoffmann

Director Product Certification & Regulatory
Affairs



23 UKCA Declaration of Conformity

ANDREAS STIHL AG & Co. KG
Badstr. 115
D-71336 Waiblingen
Germany

declare under our sole responsibility that

Designation:	Hedge trimmer
Make:	STIHL
Series:	HS 45
Serial identification number:	4228
Displacement:	27.2cm ³

conforms to the relevant provisions of UK regulations The Restriction of the Use of Certain Hazardous Substances in Electrical and Electronic Equipment Regulations 2012, Supply of Machinery (Safety) Regulations 2008, Electromagnetic Compatibility Regulations 2016 and Noise Emission in the Environment by Equipment for use Outdoors Regulations 2001 and has been manufactured in compliance with the following stand-

ards in the versions valid on the date of production:

EN ISO 10517, EN 55012, EN 61000-6-1

The measured and guaranteed sound power levels were determined in accordance with the UK regulation Noise Emission in the Environment by Equipment for Use Outdoors Regulations 2001, Schedule 8, using the ISO 11094 standard.

Measured sound power level

102 dB(A)

Guaranteed sound power level

104 dB(A)

Technical documents deposited at:

ANDREAS STIHL AG & Co. KG

The year of manufacture and serial number are indicated on the product.

Done at Waiblingen, 15.07.2021

ANDREAS STIHL AG & Co. KG

pp



Dr. Jürgen Hoffmann

Director Product Certification & Regulatory
Affairs



www.stihl.com



0458-253-0121-E



0458-253-0121-E